

1 Plan @ 1200mm AFFL
0480

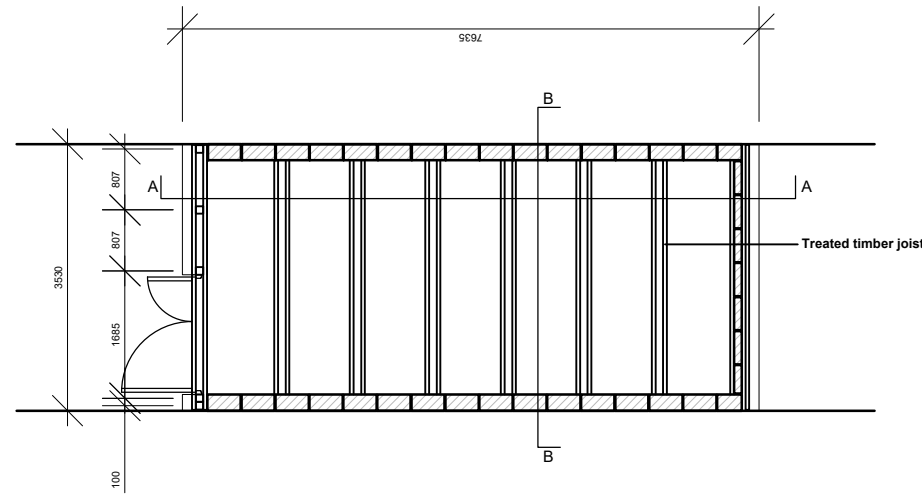

2 Plan @ 2350mm AFFL
0480

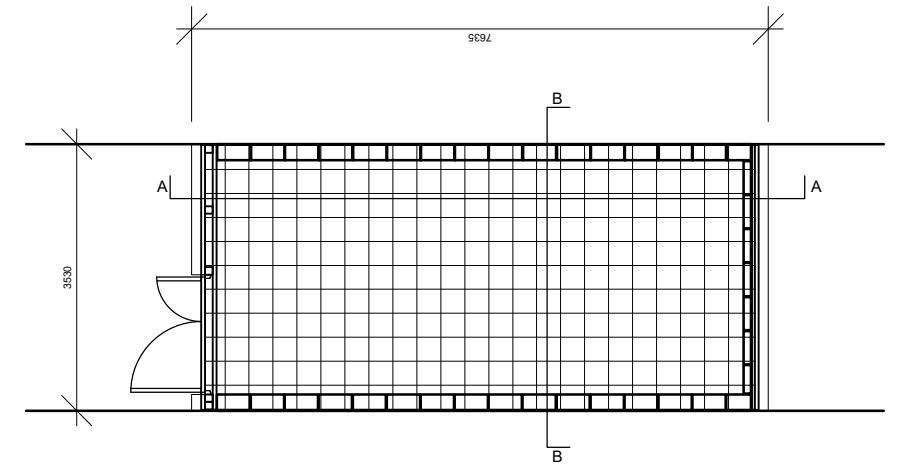

3 Roof Plan
0480

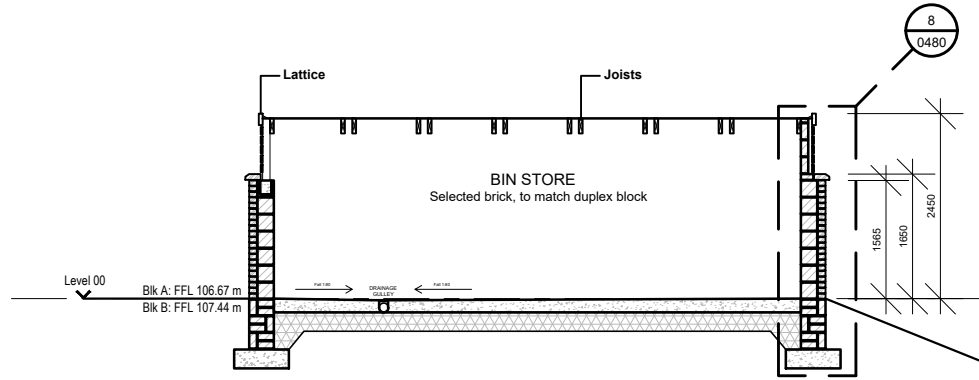

4 Section A-A
0480

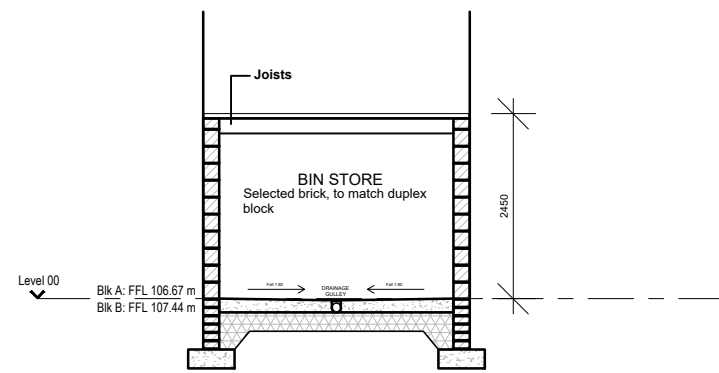

5 Section B-B
0480

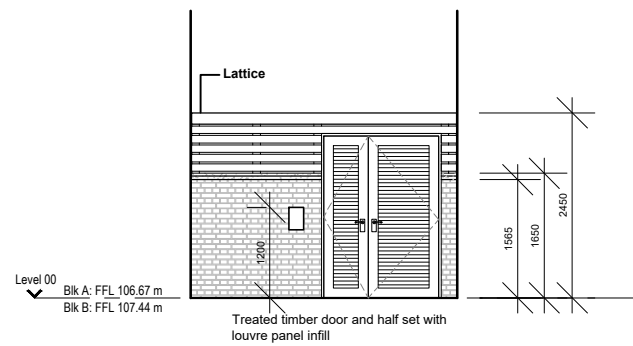

6 Front Elevation
0480

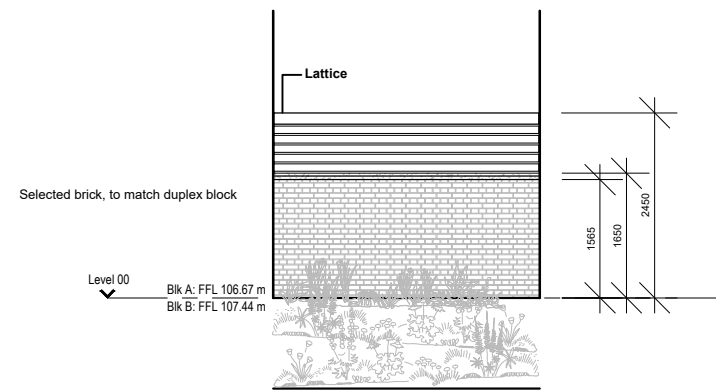

7 Rear Elevation
0480

DUPLEX TYPE A & B - BIN STORE LOCATIONS

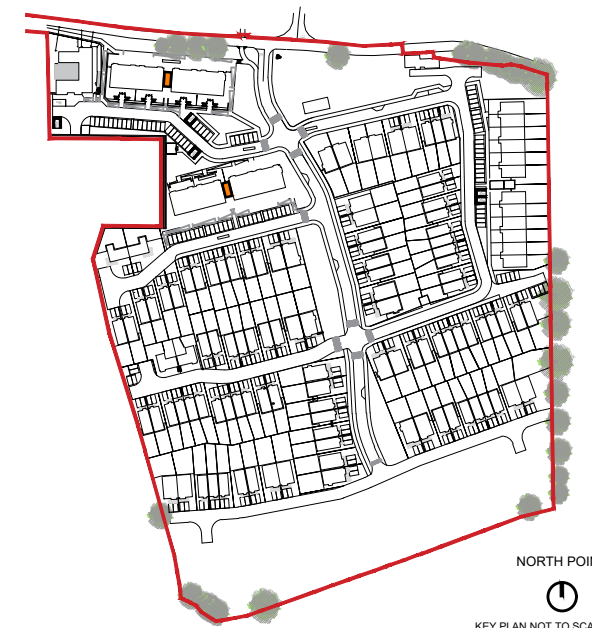

NOTES / LEGEND

NORTH POINTS AND LEVELS TO BE REFERENCED FROM SITE PLAN

Key Plan:

Rev.	Date:	Description:	By:

MOLA 2 Donnybrook Road,
Donnybrook,
Dublin 4, Ireland
Telephone +353 1 218 3900
www.molaarchitecture.com

Notes
Do not scale.
Use figured dimensions only.
This drawing is to be read in conjunction with all relevant specifications and drawings.
All dimensions to be checked on site.
In the event of any discrepancies between drawings, the contractor is to inform the Architect immediately.
© COPYRIGHT This drawing or design may not be reproduced without permission

Stage:	PLANNING
Client:	Cairn Homes Properties Ltd.
Project:	Cookstown Road Enniskerry
Drawing:	Bin Store A & B
Date:	Feb 2021
Scale:	1:100/1:20 @A3 Stage
Int. Job No.:	19010
Drawing No.:	19010_MOLA_A00_00_DR_A_XX_A00_0480_S0
Status:	SO
Revision:	00